

P1

Question Paper NEET (UG) - 2019

Time : 3 hrs.

Max. Marks : 720

Important Instructions :

1. The test is of **3 hours** duration and Test Booklet contains **180** questions. Each question carries **4** marks. For each correct response, the candidate will get **4** marks. For each incorrect response, **one mark** will be deducted from the total scores. The maximum marks are **720**.
2. Use **Blue / Black Ball point Pen only** for writing particulars on this page/markings responses.
3. Rough work is to be done on the space provided for this purpose in the Test Booklet only.
4. On completion of the test, the candidate must handover the Answer Sheet to the Invigilator before leaving the Room / Hall. *The candidates are allowed to take away this Test Booklet with them.*
5. The CODE for this Booklet is **P1**.
6. The candidates should ensure that the Answer Sheet is not folded. Do not make any stray marks on the Answer Sheet. Do not write your Roll No. anywhere else except in the specified space in the Test Booklet/Answer Sheet.
7. Each candidate must show on demand his/her Admission Card to the Invigilator.
8. No candidate, without special permission of the Superintendent or Invigilator, would leave his/her seat.
9. Use of Electronic/Manual Calculator is prohibited.
10. The candidates are governed by all Rules and Regulations of the examination with regard to their conduct in the Examination Hall. All cases of unfair means will be dealt with as per Rules and Regulations of this examination.
11. No part of the Test Booklet and Answer Sheet shall be detached under any circumstances.
12. The candidates will write the Correct Test Booklet Code as given in the Test Booklet / Answer Sheet in the Attendance Sheet.

- When a block of mass M is suspended by a long wire of length L , the length of the wire becomes $(L + l)$. The elastic potential energy stored in the extended wire is:
 - Mgl
 - MgL
 - $\frac{1}{2}Mgl$
 - $\frac{1}{2}MgL$
- A mass m is attached to a thin wire and whirled in a vertical circle. The wire is most likely to break when:
 - the mass is at the highest point
 - the wire is horizontal
 - the mass is at the lowest point
 - inclined at an angle of 60° from vertical
- Ionized hydrogen atoms and α -particles with same momenta enters perpendicular to a constant magnetic field, B . The ratio of their radii of their paths $r_H : r_\alpha$ will be :
 - 2 : 1
 - 1 : 2
 - 4 : 1
 - 1 : 4
- Body A of mass $4m$ moving with speed u collides with another body B of mass $2m$, at rest. The collision is head on and elastic in nature. After the collision the fraction of energy lost by the colliding body A is :

(1) $\frac{1}{9}$	(2) $\frac{8}{9}$
(3) $\frac{4}{9}$	(4) $\frac{5}{9}$
- In a double slit experiment, when light of wavelength 400 nm was used, the angular width of the first minima formed on a screen placed 1 m away, was found to be 0.2° . What will be the angular width of the first minima, if the entire experimental apparatus is immersed in water? ($\mu_{\text{water}} = 4/3$)

(1) 0.266°	(2) 0.15°
(3) 0.05°	(4) 0.1°
- In which of the following devices, the eddy current effect is not used?
 - Induction furnace
 - Magnetic braking in train
 - Electromagnet
 - Electric heater
- A soap bubble, having radius of 1 mm , is blown from a detergent solution having a surface tension of $2.5 \times 10^{-2} \text{ N/m}$. The pressure inside the bubble equals at a point Z_0 below the free surface of water in a container. Taking $g = 10 \text{ m/s}^2$, density of water = 10^3 kg/m^3 , the value of Z_0 is :
 - 100 cm
 - 10 cm
 - 1 cm
 - 0.5 cm
- Which colour of the light has the longest wavelength?
 - Red
 - Blue
 - Green
 - Violet
- A disc of radius 2 m and mass 100 kg rolls on a horizontal floor. Its centre of mass has speed of 20 cm/s . How much work is needed to stop it?
 - 3 J
 - 30 kJ
 - 2 J
 - 1 J
- The displacement of a particle executing simple harmonic motion is given by $y = A_0 + A \sin \omega t + B \cos \omega t$. Then the amplitude of its oscillation is given by :
 - $A_0 + \sqrt{A^2 + B^2}$
 - $\sqrt{A^2 + B^2}$
 - $\sqrt{A_0^2 + (A+B)^2}$
 - $A + B$

11. Two similar thin equi-convex lenses, of focal length f each, are kept coaxially in contact with each other such that the focal length of the combination is F_1 . When the space between the two lenses is filled with glycerin (which has the same refractive index ($\mu = 1.5$) as that of glass) then the equivalent focal length is F_2 . The ratio $F_1 : F_2$ will be :
- (1) 2 : 1 (2) 1 : 2
(3) 2 : 3 (4) 3 : 4
12. Increase in temperature of a gas filled in a container would lead to :
- (1) Increase in its mass
(2) Increase in its kinetic energy
(3) Decrease in its pressure
(4) Decrease in intermolecular distance
13. An electron is accelerated through a potential difference of 10,000 V. Its de Broglie wavelength is, (nearly) : ($m_e = 9 \times 10^{-31}$ kg)
- (1) 12.2×10^{-13} m (2) 12.2×10^{-12} m
(3) 12.2×10^{-14} m (4) 12.2 nm
14. A copper rod of 88 cm and an aluminium rod of unknown length have their increase in length independent of increase in temperature. The length of aluminium rod is : ($\alpha_{Cu} = 1.7 \times 10^{-5} K^{-1}$ and $\alpha_{Al} = 2.2 \times 10^{-5} K^{-1}$)
- (1) 6.8 cm (2) 113.9 cm
(3) 88 cm (4) 68 cm
15. Pick the wrong answer in the context with rainbow.
- (1) When the light rays undergo two internal reflections in a water drop, a secondary rainbow is formed
(2) The order of colours is reversed in the secondary rainbow
(3) An observer can see a rainbow when his front is towards the sun
(4) Rainbow is a combined effect of dispersion refraction and reflection of sunlight
16. A body weighs 200 N on the surface of the earth. How much will it weigh half way down to the centre of the earth ?
- (1) 150 N (2) 200 N
(3) 250 N (4) 100 N

17. Six similar bulbs are connected as shown in the figure with a DC source of emf E and zero internal resistance.

The ratio of power consumption by the bulbs when (i) all are glowing and (ii) in the situation when two from section A and one from section B are glowing, will be :

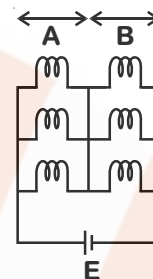

- (1) 4 : 9
(2) 9 : 4
(3) 1 : 2
(4) 2 : 1
18. For a p-type semiconductor, which of the following statements is true ?
- (1) Electrons are the majority carriers and trivalent atoms are the dopants.
(2) Holes are the majority carriers and trivalent atoms are the dopants.
(3) Holes are the majority carriers and pentavalent atoms are the dopants.
(4) Electrons are the majority carriers and pentavalent atoms are the dopants.
19. Average velocity of a particle executing SHM in one complete vibration is :
- (1) $\frac{A\omega}{2}$
(2) $A\omega$
(3) $\frac{A\omega^2}{2}$
(4) Zero
20. The unit of thermal conductivity is :
- (1) $J m K^{-1}$
(2) $J m^{-1} K^{-1}$
(3) $W m K^{-1}$
(4) $W m^{-1} K^{-1}$

21. A solid cylinder of mass 2 kg and radius 4 cm rotating about its axis at the rate of 3 rpm. The torque required to stop after 2π revolutions is

- (1) 2×10^{-6} N m
- (2) 2×10^{-3} N m
- (3) 12×10^{-4} N m
- (4) 2×10^6 N m

22. A force $F = 20 + 10y$ acts on a particle in y-direction where F is in newton and y in meter. Work done by this force to move the particle from $y = 0$ to $y = 1$ m is

- (1) 30 J
- (2) 5 J
- (3) 25 J
- (4) 20 J

23. Which of the following acts as a circuit protects device?

- (1) Conductor
- (2) Inductor
- (3) Switch
- (4) Fuse

24. In the circuits shown below, the readings of voltmeters and the ammeters will be

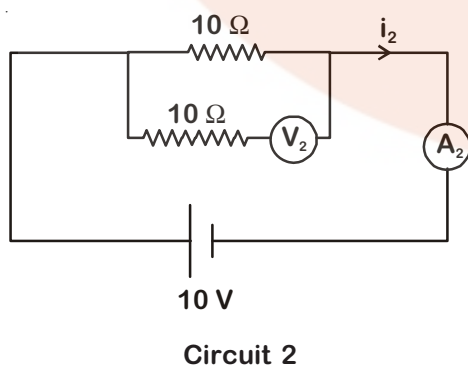
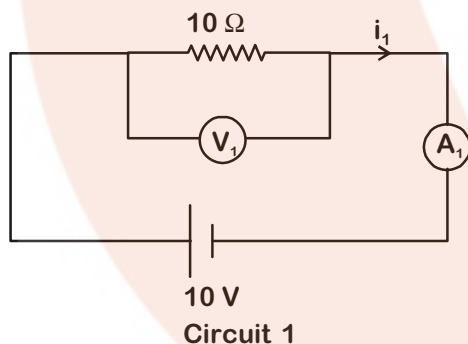

- (1) $V_2 > V_1$ and $i_1 = i_2$
- (2) $V_1 = V_2$ and $i_1 > i_2$
- (3) $V_1 = V_2$ and $i_1 = i_2$
- (4) $V_2 > V_1$ and $i_1 > i_2$

25. A hollow metal sphere of radius R is uniformly charged. The electric field due to the sphere at a distance r from the centre

- (1) Increases as r increases for $r < R$ and for $r > R$
- (2) Zero as r increases for $r < R$, decreases as r increases for $r > R$
- (3) Zero as r increases for $r < R$, increases as r increases for $r > R$
- (4) Decreases as r increases for $r < R$ and for $r > R$

26. At a point A on the earth's surface the angle of dip, $\delta = +25^\circ$. At a point B on the earth's surface the angle of dip, $\delta = -25^\circ$. We can interpret that:

- (1) A and B are both located in the northern hemisphere.
- (2) A is located in the southern hemisphere and B is located in the northern hemisphere.
- (3) A is located in the northern hemisphere and B is located in the southern hemisphere.
- (4) A and B are both located in the southern hemisphere.

27. The total energy of an electron in an atom in an orbit is -3.4 eV. Its kinetic and potential energies are, respectively:

- (1) -3.4 eV, -3.4 eV
- (2) -3.4 eV, -6.8 eV
- (3) 3.4 eV, -6.8 eV
- (4) 3.4 eV, 3.4 eV

28. In total internal reflection when the angle of incidence is equal to the critical angle for the pair of media in contact, what will be angle of refraction?

- (1) 180°
- (2) 0°
- (3) Equal to angle of incidence
- (4) 90°

29. The work done to raise a mass m from the surface of the earth to a height h, which is equal to the radius of the earth, is:

- (1) mgR
- (2) 2 mgR
- (3) $\frac{1}{2}$ mgR
- (4) $\frac{3}{2}$ mgR

30. When an object is shot from the bottom of a long smooth inclined plane kept at an angle 60° with horizontal, it can travel a distance x_1 along the plane. But when the inclination is decreased to 30° and the same object is shot with the same velocity, it can travel x_2 distance. Then $x_1 : x_2$ will be:

- (1) $1:\sqrt{2}$ (2) $\sqrt{2}:1$
(3) $1:\sqrt{3}$ (4) $1:2\sqrt{3}$

31. α -particle consists of :

- (1) 2 protons and 2 neutrons only
(2) 2 electrons, 2 protons and 2 neutrons
(3) 2 electrons and 4 protons only
(4) 2 protons only

32. The speed of a swimmer in still water is 20 m/s. The speed of river water is 10 m/s and is flowing due east. If he is standing on the south bank and wishes to cross the river along the shortest path the angle at which he should make his strokes w.r.t. north is given by :

- (1) 30° west (2) 0°
(3) 60° west (4) 45° west

33. A particle moving with velocity \vec{v} is acted by three forces shown by the vector triangle PQR. The velocity of the particle will :

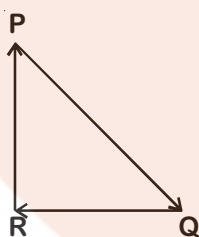

- (1) increase
(2) decrease
(3) remain constant
(4) change according to the smallest force \overline{QR}

34. Two particles A and B are moving in uniform circular motion in concentric circles of radii r_A and r_B with speed v_A and v_B respectively. Their time period of rotation is the same. The ratio of angular speed of A to that of B will be :

- (1) $r_A : r_B$ (2) $v_A : v_B$
(3) $r_B : r_A$ (4) $1 : 1$

35. A block of mass 10 kg is in contact against the inner wall of a hollow cylindrical drum of radius 1 m. The coefficient of friction between the block and the inner wall of the cylinder is 0.1. The minimum angular velocity needed for the cylinder to keep the block stationary when the cylinder is vertical and rotating about its axis, will be : ($g = 10 \text{ m/s}^2$)

- (1) $\sqrt{10}$ rad/s
(2) $\frac{10}{2\pi}$ rad/s
(3) 10 rad/s
(4) 10π rad/s

36. Two parallel infinite line charges with linear charge densities $+\lambda \text{ C/m}$ and $-\lambda \text{ C/m}$ are placed at a distance of $2R$ in free space. What is the electric field mid-way between the two line charges?

- (1) Zero
(2) $\frac{2\lambda}{\pi\epsilon_0 R} \text{ N/C}$
(3) $\frac{\lambda}{\pi\epsilon_0 R} \text{ N/C}$
(4) $\frac{\lambda}{2\pi\epsilon_0 R} \text{ N/C}$

37. Two point charges A and B, having charges $+Q$ and $-Q$ respectively, are placed at certain distance apart and force acting between them is F . If 25% charge of A is transferred to B, then force between the charges becomes :

- (1) F (2) $\frac{9F}{16}$
(3) $\frac{16F}{9}$ (4) $\frac{4F}{3}$

38. A small hole of area of cross-section 2 mm^2 is present near the bottom of a fully filled open tank of height 2 m. Taking $g = 10 \text{ m/s}^2$, the rate of flow of water through the open hole would be nearly

- (1) $12.6 \times 10^{-6} \text{ m}^3/\text{s}$ (2) $8.9 \times 10^{-6} \text{ m}^3/\text{s}$
(3) $2.23 \times 10^{-6} \text{ m}^3/\text{s}$ (4) $6.4 \times 10^{-6} \text{ m}^3/\text{s}$

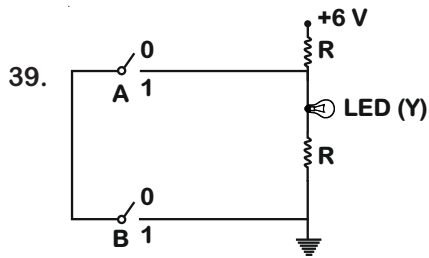

The correct Boolean operation represented by the circuit diagram drawn is :

- (1) AND (2) OR
(3) NAND (4) NOR
40. In which of the following processes, heat is neither absorbed nor released by a system?
(1) Isothermal (2) Adiabatic
(3) Isobaric (4) Isochoric
41. A 800 turn coil of effective area 0.05 m^2 is kept perpendicular to a magnetic field $5 \times 10^{-5} \text{ T}$. When the plane of the coil is rotated by 90° around any of its coplanar axis in 0.1 s , the emf induced in the coil will be:
(1) 2 V (2) 0.2 V
(3) $2 \times 10^{-3} \text{ V}$ (4) 0.02 V
42. The radius of circle, the period of revolution, initial position and sense of revolution are indicated in the fig.

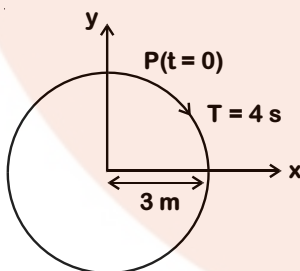

y-projection of the radius vector of rotating particle P is:

- (1) $y(t) = -3 \cos 2\pi t$, where y in m
(2) $y(t) = 4 \sin\left(\frac{\pi t}{2}\right)$, where y in m
(3) $y(t) = 3 \cos\left(\frac{3\pi t}{2}\right)$, where y in m
(4) $y(t) = 3 \cos\left(\frac{\pi t}{2}\right)$, where y in m

43. A parallel plate capacitor of capacitance $20 \mu\text{F}$ is being charged by a voltage source whose potential is changing at the rate of 3 V/s . The conduction current through the connecting wires, and the displacement current through the plates of the capacitor, would be, respectively.

- (1) Zero, $60 \mu\text{A}$
(2) $60 \mu\text{A}$, $60 \mu\text{A}$
(3) $60 \mu\text{A}$, zero
(4) Zero, zero

44. In an experiment, the percentage of error occurred in the measurement of physical quantities A, B, C and D are 1%, 2%, 3% and 4% respectively. Then the maximum percentage of

error in the measurement X, where $X = \frac{A^2 B^{1/2}}{C^{1/2} D^3}$,

will be

- (1) $\left(\frac{3}{13}\right)\%$
(2) 16%
(3) - 10%
(4) 10%

45. A cylindrical conductor of radius R is carrying a constant current. The plot of the magnitude of the magnetic field, B with the distance d from the centre of the conductor, is correctly represented by the figure :

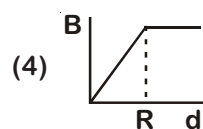
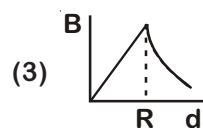
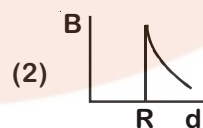
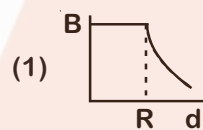

46. The number of sigma (σ) and pi (π) bonds in pent-2-en-4-yne is

- (1) 10σ bonds and 3π bonds
- (2) 8σ bonds and 5π bonds
- (3) 11σ bonds and 2π bonds
- (4) 13σ bonds and no π bonds

47. The structure of intermediate A in the following reaction, is

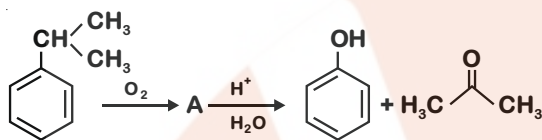

- (1)
- (2)
- (3)
- (4)

48. The correct structure of tribromooxide is

- (1)
- (2)
- (3)
- (4)

49. 4d, 5p, 5f and 6p orbitals are arranged in the order of decreasing energy. The correct option is

- (1) $5f > 6p > 5p > 4d$
- (2) $6p > 5f > 5p > 4d$
- (3) $6p > 5f > 4d > 5p$
- (4) $5f > 6p > 4d > 5p$

50. Which of the following reactions are disproportionation reaction?

- (a) $2\text{Cu}^+ \longrightarrow \text{Cu}^{2+} + \text{Cu}^0$
- (b) $3\text{MnO}_4^{2-} + 4\text{H}^+ \longrightarrow 2\text{MnO}_4^- + \text{MnO}_2 + 2\text{H}_2\text{O}$
- (c) $2\text{KMnO}_4 \xrightarrow{\Delta} \text{K}_2\text{MnO}_4 + \text{MnO}_2 + \text{O}_2$
- (d) $2\text{MnO}_4^- + 3\text{Mn}^{2+} + 2\text{H}_2\text{O} \longrightarrow 5\text{MnO}_2 + 4\text{H}^+$

Select the correct option from the following

- (1) (a) and (b) only
- (2) (a), (b) and (c)
- (3) (a), (c) and (d)
- (4) (a) and (d) only

51. Under isothermal condition, a gas at 300 K expands from 0.1 L to 0.25 L against a constant external pressure of 2 bar. The work done by the gas is

(Given that 1 L bar = 100 J)

- (1) -30 J
- (2) 5 kJ
- (3) 25 J
- (4) 30 J

52. Among the following, the one that is not a green house gas is

- (1) Nitrous oxide
- (2) Methane
- (3) Ozone
- (4) Sulphur dioxide

53. For the cell reaction

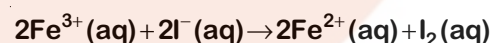

$E_{\text{Cell}}^{\circ} = 0.24 \text{ V}$ at 298 K. The standard Gibbs energy ($\Delta_r G^{\circ}$) of the cell reaction is :

- (1) $-46.32 \text{ kJ mol}^{-1}$
- (2) $-23.16 \text{ kJ mol}^{-1}$
- (3) $46.32 \text{ kJ mol}^{-1}$
- (4) $23.16 \text{ kJ mol}^{-1}$

54. Enzymes that utilize ATP in phosphate transfer require an alkaline earth metal (M) as the cofactor. M is :

- (1) Be
- (2) Mg
- (3) Ca
- (4) Sr

55. The most suitable reagent for the following conversion, is :

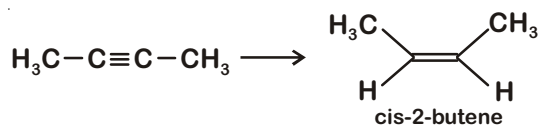

- (1) Na/liquid NH_3 (2) H_2 , Pd/C, quinoline
(3) Zn/HCl (4) $\text{Hg}^{2+}/\text{H}^+$, H_2O

56. Which is the correct thermal stability order for H_2E (E = O, S, Se, Te and Po)?

- (1) $\text{H}_2\text{S} < \text{H}_2\text{O} < \text{H}_2\text{Se} < \text{H}_2\text{Te} < \text{H}_2\text{Po}$
(2) $\text{H}_2\text{O} < \text{H}_2\text{S} < \text{H}_2\text{Se} < \text{H}_2\text{Te} < \text{H}_2\text{Po}$
(3) $\text{H}_2\text{Po} < \text{H}_2\text{Te} < \text{H}_2\text{Se} < \text{H}_2\text{S} < \text{H}_2\text{O}$
(4) $\text{H}_2\text{Se} < \text{H}_2\text{Te} < \text{H}_2\text{Po} < \text{H}_2\text{O} < \text{H}_2\text{S}$

57. Which of the following is incorrect statement?

- (1) PbF_4 is covalent in nature
(2) SiCl_4 is easily hydrolysed
(3) GeX_4 (X = F, Cl, Br, I) is more stable than GeX_2
(4) SnF_4 is ionic in nature

58. Match the following :

- (a) Pure nitrogen (i) Chlorine
(b) Haber process (ii) Sulphuric acid
(c) Contact process (iii) Ammonia
(d) Deacon's process (iv) Sodium azide or Barium azide

Which of the following is the correct option?

- (a) (b) (c) (d)
(1) (i) (ii) (iii) (iv)
(2) (ii) (iv) (i) (iii)
(3) (iii) (iv) (ii) (i)
(4) (iv) (iii) (ii) (i)

59. Which of the following diatomic molecular species has only π bonds according to Molecular Orbital Theory?

- (1) O_2
(2) N_2
(3) C_2
(4) Be_2

60. For the second period elements the correct increasing order of first ionisation enthalpy is:

- (1) $\text{Li} < \text{Be} < \text{B} < \text{C} < \text{N} < \text{O} < \text{F} < \text{Ne}$
(2) $\text{Li} < \text{B} < \text{Be} < \text{C} < \text{O} < \text{N} < \text{F} < \text{Ne}$
(3) $\text{Li} < \text{B} < \text{Be} < \text{C} < \text{N} < \text{O} < \text{F} < \text{Ne}$
(4) $\text{Li} < \text{Be} < \text{B} < \text{C} < \text{O} < \text{N} < \text{F} < \text{Ne}$

61. The biodegradable polymer is:

- (1) Nylon-6,6
(2) Nylon 2-Nylon 6
(3) Nylon-6
(4) Buna-S

62. pH of a saturated solution of $\text{Ca}(\text{OH})_2$ is 9. The solubility product (K_{sp}) of $\text{Ca}(\text{OH})_2$ is:

- (1) 0.5×10^{-15}
(2) 0.25×10^{-10}
(3) 0.125×10^{-15}
(4) 0.5×10^{-10}

63. If the rate constant for a first order reaction is k, the time (t) required for the completion of 99% of the reaction is given by:

- (1) $t = 0.693/k$
(2) $t = 6.909/k$
(3) $t = 4.606/k$
(4) $t = 2.303/k$

64. The non-essential amino acid among the following is:

- (1) valine
(2) leucine
(3) alanine
(4) lysine

65. Among the following, the reaction that proceeds through an electrophilic substitution, is:

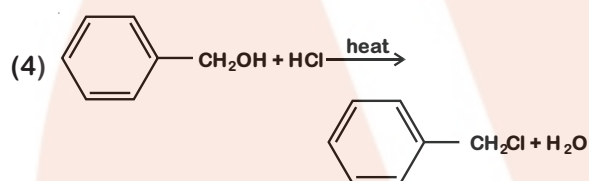
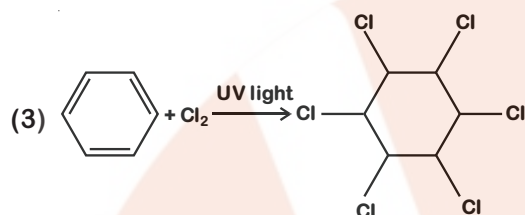
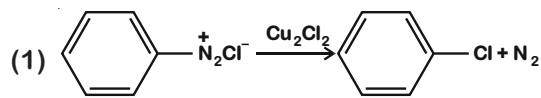

66. The mixture that forms maximum boiling azeotrope is:

- (1) Water + Nitric acid
- (2) Ethanol + Water
- (3) Acetone + Carbon disulphide
- (4) Heptane + Octane

67. For the chemical reaction

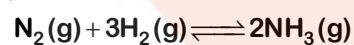

the correct option is:

(1) $-\frac{1}{3} \frac{d[\text{H}_2]}{dt} = -\frac{1}{2} \frac{d[\text{NH}_3]}{dt}$

(2) $-\frac{d[\text{N}_2]}{dt} = 2 \frac{d[\text{NH}_3]}{dt}$

(3) $-\frac{d[\text{N}_2]}{dt} = \frac{1}{2} \frac{d[\text{NH}_3]}{dt}$

(4) $3 \frac{d[\text{H}_2]}{dt} = 2 \frac{d[\text{NH}_3]}{dt}$

68. The number of moles of hydrogen molecules required to produce 20 moles of ammonia through Haber's process is :

- (1) 10
- (2) 20
- (3) 30
- (4) 40

69. The compound that is most difficult to protonate is :

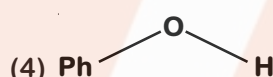
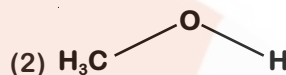
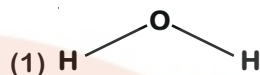

70. For an ideal solution, the correct option is :

- (1) $\Delta_{\text{mix}} S = 0$ at constant T and P
- (2) $\Delta_{\text{mix}} V \neq 0$ at constant T and P
- (3) $\Delta_{\text{mix}} H = 0$ at constant T and P
- (4) $\Delta_{\text{mix}} G = 0$ at constant T and P

71. Conjugate base for Brønsted acids H_2O and HF are :

- (1) OH^- and H_2F^+ , respectively
- (2) H_3O^+ and F^- , respectively
- (3) OH^- and F^- , respectively
- (4) H_3O^+ and H_2F^+ , respectively

72. Which mixture of the solutions will lead to the formation of negatively charged colloidal $[\text{AgI}]^-$ sol. ?

- (1) 50 mL of 1 M AgNO_3 + 50 mL of 1.5 M KI
- (2) 50 mL of 1 M AgNO_3 + 50 mL of 2 M KI
- (3) 50 mL of 2 M AgNO_3 + 50 mL of 1.5 M KI
- (4) 50 mL of 0.1 M AgNO_3 + 50 mL of 0.1 M KI

73. Among the following, the narrow spectrum antibiotic is :

- (1) Penicillin G
- (2) Ampicillin
- (3) Amoxycillin
- (4) Chloramphenicol

74. An alkene "A" on reaction with O_3 and $Zn-H_2O$ gives propanone and ethanal in equimolar ratio. Addition of HCl to alkene "A" gives "B" as the major product. The structure of product "B" is:

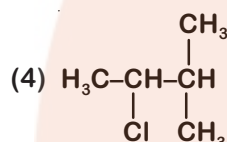
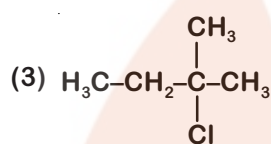
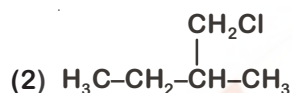
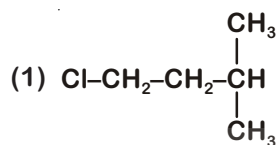

75. What is the correct electronic configuration of the central atom in $K_4[Fe(CN)_6]$ based on crystal field theory?

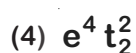
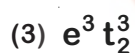
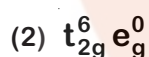
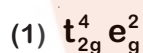

76. Identify the incorrect statement related to PCl_5 from the following:

- (1) Three equatorial P-Cl bonds make an angle of 120° with each other
- (2) Two axial P-Cl bonds make an angle of 180° with each other
- (3) Axial P-Cl bonds are longer than equatorial P-Cl bonds
- (4) PCl_5 molecule is non-reactive

77. Which will make basic buffer?

- (1) 50 mL of 0.1 M NaOH + 25 mL of 0.1 M CH_3COOH
- (2) 100 mL of 0.1 M CH_3COOH + 100 mL of 0.1 M NaOH
- (3) 100 mL of 0.1 M HCl + 200 mL of 0.1 M NH_4OH
- (4) 100 mL of 0.1 M HCl + 100 mL of 0.1 M NaOH

78. The major product of the following reaction is:

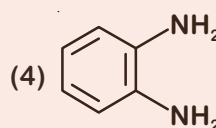
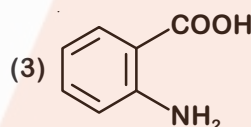
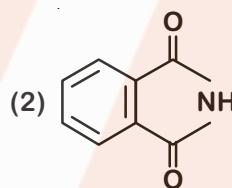
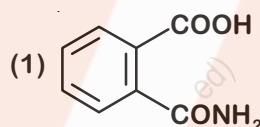
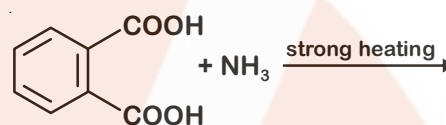

79. Match the Xenon compounds in Column-I with its structure in Column-II and assign the correct code:

Column-I	Column-II
(a) XeF_4	(i) pyramidal
(b) XeF_6	(ii) square planar
(c) $XeOF_4$	(iii) distorted octahedral
(d) XeO_3	(iv) square pyramidal

Code:

(a) (b) (c) (d)

(1) (i) (ii) (iii) (iv)

(2) (ii) (iii) (iv) (i)

(3) (ii) (iii) (i) (iv)

(4) (iii) (iv) (i) (ii)

80. The manganate and permanganate ions are tetrahedral, due to :

(1) The π -bonding involves overlap of p-orbitals of oxygen with d-orbitals of manganese

(2) There is no π -bonding

(3) The π -bonding involves overlap of p-orbitals of oxygen with p-orbitals of manganese

(4) The π -bonding involves overlap of d-orbitals of oxygen with d-orbitals of manganese

81. Which of the following species is not stable?

(1) $[\text{SiF}_6]^{2-}$ (2) $[\text{GeCl}_6]^{2-}$

(3) $[\text{Sn}(\text{OH})_6]^{2-}$ (4) $[\text{SiCl}_6]^{2-}$

82. For a cell involving one electron $E^\circ_{\text{cell}} = 0.59 \text{ V}$ at 298 K, the equilibrium constant for the cell reaction is :

[Given that $\frac{2.303 RT}{F} = 0.059 \text{ V}$ at $T = 298 \text{ K}$]

(1) 1.0×10^2

(2) 1.0×10^5

(3) 1.0×10^{10}

(4) 1.0×10^{30}

83. Which of the following is an amphoteric hydroxide?

(1) $\text{Sr}(\text{OH})_2$ (2) $\text{Ca}(\text{OH})_2$

(3) $\text{Mg}(\text{OH})_2$ (4) $\text{Be}(\text{OH})_2$

84. A gas at 350 K and 15 bar has molar volume 20 percent smaller than that for an ideal gas under the same conditions. The correct option about the gas and its compressibility factor (Z) is :

(1) $Z > 1$ and attractive forces are dominant

(2) $Z > 1$ and repulsive forces are dominant

(3) $Z < 1$ and attractive forces are dominant

(4) $Z < 1$ and repulsive forces are dominant

85. A compound is formed by cation C and anion A. The anions form hexagonal close packed (hcp) lattice and the cations occupy 75% of octahedral voids. The formula of the compound is :

(1) C_2A_3 (2) C_3A_2

(3) C_3A_4 (4) C_4A_3

86. In which case change in entropy is negative?

(1) Evaporation of water

(2) Expansion of a gas at constant temperature

(3) Sublimation of solid to gas

(4) $2\text{H}(\text{g}) \rightarrow \text{H}_2(\text{g})$

87. Which of the following series of transitions in the spectrum of hydrogen atom falls in visible region?

(1) Lyman series

(2) Balmer series

(3) Paschen series

(4) Brackett series

88. The method used to remove temporary hardness of water is :

(1) Calgon's method

(2) Clark's method

(3) Ion-exchange method

(4) Synthetic resins method

89. Which one is malachite from the following?

(1) CuFeS_2

(2) $\text{Cu}(\text{OH})_2$

(3) Fe_3O_4

(4) $\text{CuCO}_3 \cdot \text{Cu}(\text{OH})_2$

90. The correct order of the basic strength of methyl substituted amines in aqueous solution is :

(1) $(\text{CH}_3)_2\text{NH} > \text{CH}_3\text{NH}_2 > (\text{CH}_3)_3\text{N}$

(2) $(\text{CH}_3)_3\text{N} > \text{CH}_3\text{NH}_2 > (\text{CH}_3)_2\text{NH}$

(3) $(\text{CH}_3)_3\text{N} > (\text{CH}_3)_2\text{NH} > \text{CH}_3\text{NH}_2$

(4) $\text{CH}_3\text{NH}_2 > (\text{CH}_3)_2\text{NH} > (\text{CH}_3)_3\text{N}$

91. The Earth Summit held in Rio de Janeiro in 1992 was called
- (1) to reduce CO₂ emissions and global warming
 - (2) for conservation of biodiversity and sustainable utilization of its benefits
 - (3) to assess threat posed to native species by invasive weed species
 - (4) for immediate steps to discontinue use of CFCs that were damaging the ozone layer
92. Colostrum the yellowish fluid, secreted by mother during the initial days of lactation is very essential to impart immunity to the new born infants because it contains :
- (1) Natural killer cells
 - (2) Monocytes
 - (3) Macrophages
 - (4) Immunoglobulin A
93. Grass leaves curl inwards during very dry weather. Select the most appropriate reason from the following :
- (1) Closure of stomata
 - (2) Flaccidity of bulliform cells
 - (3) Shrinkage of air spaces in spongy mesophyll
 - (4) Tyloses in vessels
94. The shorter and longer arms of a submetacentric chromosome are referred to as
- (1) s-arm and l-arm respectively
 - (2) p-arm and q-arm respectively
 - (3) q-arm and p-arm respectively
 - (4) m-arm and n-arm respectively
95. Respiratory Quotient (RQ) value of tripalmitin is
- (1) 0.9
 - (2) 0.7
 - (3) 0.07
 - (4) 0.09
96. Which of the following is a commercial blood cholesterol lowering agent?
- (1) Cyclosporin A
 - (2) Statin
 - (3) Streptokinase
 - (4) Lipases
97. Match the following structures with their respective location in organs
- | | | |
|--------------------------|-------|-----------------|
| (a) Crypts of Lieberkuhn | (i) | Pancreas |
| (b) Glisson's Capsule | (ii) | Duodenum |
| (c) Islets of Langerhans | (iii) | Small intestine |
| (d) Brunner's Glands | (iv) | Liver |
- Select the correct option from the following
- | | | | | |
|-----|-------|------|------|-------|
| | (a) | (b) | (c) | (d) |
| (1) | (iii) | (i) | (ii) | (iv) |
| (2) | (ii) | (iv) | (i) | (iii) |
| (3) | (iii) | (iv) | (i) | (ii) |
| (4) | (iii) | (ii) | (i) | (iv) |
98. Which of the following is the most important cause for animals and plants being driven to extinction?
- (1) Habitat loss and fragmentation
 - (2) Drought and floods
 - (3) Economic exploitation
 - (4) Alien species invasion
99. Which part of the brain is responsible for thermoregulation?
- (1) Cerebrum
 - (2) Hypothalamus
 - (3) Corpus callosum
 - (4) Medulla oblongata
100. Consider following features
- (a) Organ system level of organisation
 - (b) Bilateral symmetry
 - (c) True coelomates with segmentation of body
- Select the correct option of animal groups which possess all the above characteristics
- (1) Annelida, Arthropoda and Chordata
 - (2) Annelida, Arthropoda and Mollusca
 - (3) Arthropoda, Mollusca and Chordata
 - (4) Annelida, Mollusca and Chordata

101. Select the correct sequence of organs in the alimentary canal of cockroach starting from mouth
- (1) Pharynx → Oesophagus → Crop → Gizzard → Ileum → Colon → Rectum
 - (2) Pharynx → Oesophagus → Gizzard → Crop → Ileum → Colon → Rectum
 - (3) Pharynx → Oesophagus → Gizzard → Ileum → Crop → Colon → Rectum
 - (4) Pharynx → Oesophagus → Ileum → Crop → Gizzard → Colon → Rectum
102. Which of the following pairs of gases is mainly responsible for green house effect?
- (1) Ozone and Ammonia
 - (2) Oxygen and Nitrogen
 - (3) Nitrogen and Sulphur dioxide
 - (4) Carbon dioxide and Methane
103. Which of the following muscular disorders is inherited?
- (1) Tetany
 - (2) Muscular dystrophy
 - (3) Myasthenia gravis
 - (4) Botulism
104. The ciliated epithelial cells are required to move particles or mucus in a specific direction. In humans, these cells are mainly present in
- (1) Bile duct and Bronchioles
 - (2) Fallopian tubes and Pancreatic duct
 - (3) Eustachian tube and Salivary duct
 - (4) Bronchioles and Fallopian tubes
105. Match the Column-I with Column-II
- | Column-I | Column-II |
|-------------------------------------|-----------------------------------|
| (a) P - wave | (i) Depolarisation of ventricles |
| (b) QRS complex | (ii) Repolarisation of ventricles |
| (c) T - wave | (iii) Coronary ischemia |
| (d) Reduction in the size of T-wave | (iv) Depolarisation of atria |
| | (v) Repolarisation of atria |
- Select the correct option.
- | | (a) | (b) | (c) | (d) |
|-----|------|-------|------|-------|
| (1) | (iv) | (i) | (ii) | (iii) |
| (2) | (iv) | (i) | (ii) | (v) |
| (3) | (ii) | (i) | (v) | (iii) |
| (4) | (ii) | (iii) | (v) | (iv) |
106. Which one of the following is not a method *in situ* conservation of biodiversity?
- (1) Biosphere Reserve
 - (2) Wildlife Sanctuary
 - (3) Botanical Garden
 - (4) Sacred Grove
107. In a species, the weight of newborn ranges from 2 to 5 kg. 97% of the newborn with an average weight between 3 to 3.3 kg survive whereas 99% of the infants born with weight from 2 to 2.5 kg or 4.5 to 5 kg die. Which type of selection process is taking place?
- (1) Directional Selection
 - (2) Stabilizing Selection
 - (3) Disruptive Selection
 - (4) Cyclical Selection
108. The correct sequence of phases of cell cycle is :
- (1) M → G₁ → G₂ → S
 - (2) G₁ → G₂ → S → M
 - (3) S → G₁ → G₂ → M
 - (4) G₁ → S → G₂ → M
109. How does steroid hormone influence the cellular activities?
- (1) Changing the permeability of the cell membrane
 - (2) Binding to DNA and forming a gene-hormone complex
 - (3) Activating cyclic AMP located on the cell membrane
 - (4) Using aquaporin channels as second messenger
110. Which of the following statements is not correct?
- (1) Lysosomes have numerous hydrolytic enzymes
 - (2) The hydrolytic enzymes of lysosomes are active under acidic pH
 - (3) Lysosomes are membrane bound structures
 - (4) Lysosomes are formed by the process of packaging in the endoplasmic reticulum
111. Which one of the following statements regarding post-fertilization development in flowering plants is incorrect?
- (1) Ovary develops into fruit
 - (2) Zygote develops into embryo
 - (3) Central cell develops into endosperm
 - (4) Ovules develop into embryo sac

112. Concanavalin A is
 (1) an alkaloid (2) an essential oil
 (3) a lectin (4) a pigment
113. Which one of the following equipments is essentially required for growing microbes on a large scale, for industrial production of enzymes?
 (1) BOD incubator
 (2) Sludge digester
 (3) Industrial oven
 (4) Bioreactor
114. Consider the following statement :
 (A) Coenzyme or metal ion that is tightly bound to enzyme protein is called prosthetic group.
 (B) A complete catalytic active enzyme with its bound prosthetic group is called apoenzyme.
 Select the correct option.
 (1) Both (A) and (B) are true.
 (2) (A) is true but (B) is false.
 (3) Both (A) and (B) are false.
 (4) (A) is false but (B) is true.
115. Purines found both in DNA and RNA are
 (1) Adenine and thymine
 (2) Adenine and guanine
 (3) Guanine and cytosine
 (4) Cytosine and thymine
116. Select the correct sequence for transport of sperm cells in male reproductive system.
 (1) Testis → Epididymis → Vasa efferentia → Rete testis → Inguinal canal → Urethra
 (2) Seminiferous tubules → Rete testis → Vasa efferentia → Epididymis → Vas deferens → Ejaculatory duct → Urethra → Urethral meatus
 (3) Seminiferous tubules → Vasa efferentia → Epididymis → Inguinal canal → Urethra
 (4) Testis → Epididymis → Vasa efferentia → Vas deferens → Ejaculatory duct → Inguinal canal → Urethra → Urethral meatus
117. Match the hominids with their correct brain size :
 (a) *Homo habilis* (i) 900 cc
 (b) *Homo neanderthalensis* (ii) 1350 cc
 (c) *Homo erectus* (iii) 650-800 cc
 (d) *Homo sapiens* (iv) 1400 cc
 Select the correct option.

	(a)	(b)	(c)	(d)
(1)	(iii)	(i)	(iv)	(ii)
(2)	(iii)	(ii)	(i)	(iv)
(3)	(iii)	(iv)	(i)	(ii)
(4)	(iv)	(iii)	(i)	(ii)
118. Variations caused by mutation, as proposed by Hugo de Vries are
 (1) random and directional
 (2) random and directionless
 (3) small and directional
 (4) small and directionless
119. Which of the following pair of organelles does not contain DNA?
 (1) Mitochondria and Lysosomes
 (2) Chloroplast and Vacuoles
 (3) Lysosomes and Vacuoles
 (4) Nuclear envelope and Mitochondria
120. Due to increasing air-borne allergens and pollutants, many people in urban areas are suffering from respiratory disorder causing wheezing due to
 (1) benign growth on mucous lining of nasal cavity
 (2) inflammation of bronchi and bronchioles
 (3) proliferation of fibrous tissues and damage of the alveolar walls
 (4) reduction in the secretion of surfactants by pneumocytes.
121. Select the incorrect statement.
 (1) Male fruit fly is heterogametic
 (2) In male grasshoppers 50% of sperms have no sex-chromosome
 (3) In domesticated fowls, sex of progeny depends on the type of sperm rather than egg
 (4) Human males have one of their sex-chromosome much shorter than the other

122. DNA precipitation out of a mixture of biomolecules can be achieved by treatment with
- (1) Isopropanol
 - (2) Chilled ethanol
 - (3) Methanol at room temperature
 - (4) Chilled chloroform
123. Select the correct group of biocontrol agents.
- (1) *Bacillus thuringiensis*, Tobacco mosaic virus, Aphids
 - (2) *Trichoderma*, *Baculovirus*, *Bacillus thuringiensis*
 - (3) *Oscillatoria*, *Rhizobium*, *Trichoderma*
 - (4) *Nostoc*, *Azospirillum*, *Nucleopolyhedrovirus*
124. Select the incorrect statement.
- (1) Inbreeding increases homozygosity
 - (2) Inbreeding is essential to evolve purelines in any animal.
 - (3) Inbreeding selects harmful recessive genes that reduce fertility and productivity
 - (4) Inbreeding helps in accumulation of superior genes and elimination of undesirable genes
125. Match the following organisms with the products they produce
- | | |
|-------------------------------------|-------------------|
| (a) <i>Lactobacillus</i> | (i) Cheese |
| (b) <i>Saccharomyces cerevisiae</i> | (ii) Curd |
| (c) <i>Aspergillus niger</i> | (iii) Citric Acid |
| (d) <i>Acetobacter aceti</i> | (iv) Bread |
| | (v) Acetic Acid |
- Select the correct option.
- | (a) | (b) | (c) | (d) |
|-----------|------|-------|-------|
| (1) (ii) | (iv) | (v) | (iii) |
| (2) (ii) | (iv) | (iii) | (v) |
| (3) (iii) | (iv) | (v) | (i) |
| (4) (ii) | (i) | (iii) | (v) |
126. What is the direction of movement of sugars in phloem?
- (1) Non-multidirectional
 - (2) Upward
 - (3) Downward
 - (4) Bi-directional
127. In some plants, the female gamete develops into embryo without fertilization. This phenomenon is known as
- (1) Autogamy
 - (2) Parthenocarpy
 - (3) Syngamy
 - (4) Parthenogenesis
128. Persistent nucellus in the seed is known as
- (1) Chalaza
 - (2) Perisperm
 - (3) Hilum
 - (4) Tegmen
129. What map unit (Centimorgan) is adopted in the construction of genetic maps?
- (1) A unit of distance between two expressed genes representing 10% cross over.
 - (2) A unit of distance between two expressed genes representing 100% cross over.
 - (3) A unit of distance between genes on chromosomes, representing 1% cross over.
 - (4) A unit of distance between genes on chromosomes, representing 50% cross over.
130. What would be the heart rate of a person if the cardiac output is 5 L, blood volume in the ventricles at the end of diastole is 100 mL and at the end of ventricular systole is 50 mL?
- (1) 50 beats per minute
 - (2) 75 beats per minute
 - (3) 100 beats per minute
 - (4) 125 beats per minute
131. *Thiobacillus* is a group of bacteria helpful in carrying out
- (1) Nitrogen fixation
 - (2) Chemoautotrophic fixation
 - (3) Nitrification
 - (4) Denitrification
132. Which of the following factors is responsible for the formation of concentrated urine?
- (1) Low levels of antidiuretic hormone
 - (2) Maintaining hyperosmolarity towards inner medullary interstitium in the kidneys.
 - (3) Secretion of erythropoietin by Juxtaglomerular complex
 - (4) Hydrostatic pressure during glomerular filtration

133. Which of the following statements regarding mitochondria is incorrect?
- (1) Outer membrane is permeable to monomers of carbohydrates, fats and proteins.
 - (2) Enzymes of electron transport are embedded in outer membrane.
 - (3) Inner membrane is convoluted with infoldings.
 - (4) Mitochondrial matrix contains single circular DNA molecule and ribosomes.
134. Xylem translocates.
- (1) Water only
 - (2) Water and mineral salts only
 - (3) Water, mineral salts and some organic nitrogen only
 - (4) Water, mineral salts, some organic nitrogen and hormones
135. Cell in G_0 phase :
- (1) exit the cell cycle
 - (2) enter the cell cycle
 - (3) suspend the cell cycle
 - (4) terminate the cell cycle
136. Which of the statements given below is not true about formation of Annual Rings in trees?
- (1) Annual ring is a combination of spring wood and autumn wood produced in a year
 - (2) Differential activity of cambium causes light and dark bands of tissue early and late wood respectively.
 - (3) Activity of cambium depends upon variation in climate.
 - (4) Annual rings are not prominent in trees of temperate region.
137. Which of the following ecological pyramids is generally inverted?
- (1) Pyramid of numbers in grassland
 - (2) Pyramid of energy
 - (3) Pyramid of biomass in a forest
 - (4) Pyramid of biomass in a sea
138. Placentation in which ovules develop on the inner wall of the ovary or in peripheral part, is
- (1) Basal
 - (2) Axile
 - (3) Parietal
 - (4) Free central
139. Which of the following protocols did aim for reducing emission of chlorofluorocarbons into the atmosphere?
- (1) Montreal Protocol
 - (2) Kyoto Protocol
 - (3) Gothenburg Protocol
 - (4) Geneva Protocol
140. Which of the following contraceptive methods do involve a role of hormone?
- (1) Lactational amenorrhea, Pills Emergency contraceptives.
 - (2) Barrier method, Lactational amenorrhea, Pills.
 - (3) CuT, Pills, Emergency contraceptives.
 - (4) Pills, Emergency contraceptives, Barrier methods.
141. Tidal Volume and Expiratory Reserve Volume of an athlete is 500 mL and 1000 mL, respectively. What will be his Expiratory Capacity if the Residual Volume is 1200 mL?
- (1) 1500 mL
 - (2) 1700 mL
 - (3) 2200 mL
 - (4) 2700 mL
142. What is the fate of the male gametes discharged in the synergid?
- (1) One fuses with egg other(s) degenerate (s) in the synergid.
 - (2) All fuse with the egg.
 - (3) One fuses with the egg, other(s) fuse(s) with synergid nucleus.
 - (4) One fuses with the egg and other fuses with central cell nuclei.
143. What is the site of perception of photoperiod necessary for induction of flowering in plants?
- (1) Lateral buds
 - (2) Pulvinus
 - (3) Shoot apex
 - (4) Leaves
144. Select the correctly written scientific name of Mango which was first described by Carolus Linnaeus :
- (1) *Mangifera indica* Car. Linn.
 - (2) *Mangifera indica* Linn.
 - (3) *Mangifera indica*
 - (4) *Mangifera Indica*

145. Following statements describe the characteristics of the enzyme Restriction Endonuclease. Identify the incorrect statement.
- (1) The enzyme cuts DNA molecule at identified position within the DNA.
 - (2) The enzyme binds DNA at specific sites and cuts only one of the two strands.
 - (3) The enzyme cuts the sugar-phosphate backbone at specific sites on each strand.
 - (4) The enzyme recognizes a specific palindromic nucleotide sequence in the DNA.
146. From evolutionary point of view, retention of the female gametophyte with developing young embryo on the parent sporophyte for some time, is first observed in :
- (1) Liverworts (2) Mosses
 - (3) Pteridophytes (4) Gymnosperms
147. In *Antirrhinum* (Snapdragon), a red flower was crossed with a white flower and in F_1 generation pink flowers were obtained. When pink flowers were selfed, the F_2 generation showed white, red and pink flowers. Choose the incorrect statement from the following :
- (1) This experiment does not follow the Principle of Dominance.
 - (2) Pink colour in F_1 is due to incomplete dominance.
 - (3) Ratio of F_2 is $\frac{1}{4}$ (Red) : $\frac{2}{4}$ (Pink) : $\frac{1}{4}$ (White)
 - (4) Law of Segregation does not apply in this experiment
148. Conversion of glucose to glucose-6-phosphate, the first irreversible reaction of glycolysis, is catalyzed by
- (1) Aldolase
 - (2) Hexokinase
 - (3) Enolase
 - (4) Phosphofructokinase
149. Drug called 'Heroin' is synthesized by
- (1) methylation of morphine
 - (2) acetylation of morphine
 - (3) glycosylation of morphine
 - (4) nitration of morphine
150. Select the hormone-releasing Intra-Uterine Devices.
- (1) Vaults, LNG-20
 - (2) Multiload 375, Progestasert
 - (3) Progestasert, LNG-20
 - (4) Lippes Loop, Multiload 375
151. A gene locus has two alleles A, a. If the frequency of dominant allele A is 0.4, then what will be the frequency of homozygous dominant, heterozygous and homozygous recessive individuals in the population?
- (1) 0.36(AA); 0.48(Aa); 0.16(aa)
 - (2) 0.16(AA); 0.24(Aa); 0.36(aa)
 - (3) 0.16(AA); 0.48(Aa); 0.36(aa)
 - (4) 0.16(AA); 0.36(Aa); 0.48(aa)
152. Which of the following is true for Golden rice?
- (1) It is Vitamin A enriched, with a gene from daffodil
 - (2) It is pest resistant, with a gene from *Bacillus thuringiensis*
 - (3) It is drought tolerant, developed using *Agrobacterium* vector
 - (4) It has yellow grains, because of a gene introduced from a primitive variety of rice
153. Pinus seed cannot germinate and established without fungal association. This is because :
- (1) its embryo is immature.
 - (2) it has obligate association with mycorrhizae.
 - (3) it has very hard seed coat.
 - (4) its seeds contain inhibitors that prevent germination.
154. Which of the following features of genetic code does allow bacteria to produce human insulin by recombinant DNA technology?
- (1) Genetic code is not ambiguous
 - (2) Genetic code is redundant
 - (3) Genetic code is nearly universal
 - (4) Genetic code is specific
155. Which of the following sexually transmitted diseases is not completely curable?
- (1) Gonorrhoea (2) Genital warts
 - (3) Genital herpes (4) Chlamydia

156. Which of the following statements is incorrect?

- (1) Viroids lack a protein coat.
- (2) Viruses are obligate parasites.
- (3) Infective constituent in viruses is the protein coat.
- (4) Prions consist of abnormally folded proteins.

157. Match the following organisms with their respective characteristics :

- | | |
|--------------------------|-------------------------|
| (a) <i>Pila</i> | (i) Flame cells |
| (b) <i>Bombyx</i> | (ii) Comb plates |
| (c) <i>Pleurobrachia</i> | (iii) Radula |
| (d) <i>Taenia</i> | (iv) Malpighian tubules |

Select the correct option from the following :

- | | | | |
|-----------|------|-------|------|
| (a) | (b) | (c) | (d) |
| (1) (iii) | (ii) | (i) | (iv) |
| (2) (iii) | (iv) | (ii) | (i) |
| (3) (ii) | (iv) | (iii) | (i) |
| (4) (iii) | (ii) | (iv) | (i) |

158. Expressed Sequence Tags (ESTs) refers to :

- (1) Genes expressed as RNA
- (2) Polypeptide expression
- (3) DNA polymorphism
- (4) Novel DNA sequences

159. Which is of the following statements is incorrect?

- (1) Morels and truffles are edible delicacies.
- (2) *Claviceps* is a source of many alkaloids and LSD.
- (3) Conidia are produced exogenously and ascospores endogenously.
- (4) Yeasts have filamentous bodies with long thread-like hyphae.

160. Match Column - I Column - II

- | Column - I | Column - II |
|----------------|---|
| (a) Saprophyte | (i) Symbiotic association of fungi with plant roots |
| (b) Parasite | (ii) Decomposition of dead organic materials |
| (c) Lichens | (iii) Living on living plants or animals |
| (d) Mycorrhiza | (iv) Symbiotic association of algae and fungi |

Choose the correct answer from the option given below

- | | | | |
|-----------|-------|-------|------|
| (a) | (b) | (c) | (d) |
| (1) (i) | (ii) | (iii) | (iv) |
| (2) (iii) | (ii) | (i) | (iv) |
| (3) (ii) | (i) | (iii) | (iv) |
| (4) (ii) | (iii) | (iv) | (i) |

161. Which of the following glucose transporters is insulin-dependent?

- | | |
|--------------|-------------|
| (1) GLUT I | (2) GLUT II |
| (3) GLUT III | (4) GLUT IV |

162. Which of the following immune responses is responsible for rejection of kidney graft?

- (1) Auto-immune response
- (2) Humoral immune response
- (3) Inflammatory immune response
- (4) Cell-mediated immune response

163. Use of an artificial kidney during hemodialysis may result in :

- (a) Nitrogenous waste build-up in the body
- (b) Non-elimination of excess potassium ions
- (c) Reduced absorption of calcium ions from gastro-intestinal tract
- (d) Reduced RBC production

Which of the following options is the most appropriate?

- (1) (a) and (b) are correct
- (2) (b) and (c) are correct
- (3) (c) and (d) are correct
- (4) (a) and (d) are correct

164. Which of the following statements is correct?

- (1) Cornea is an external, transparent and protective proteinaceous covering of the eye-ball.
- (2) Cornea consists of dense connective tissue of elastin and can repair itself.
- (3) Cornea is convex, transparent layer which is highly vascularised.
- (4) Cornea consists of dense matrix of collagen and is the most sensitive portion the eye.

165. The frequency of recombination between gene pairs on the same chromosome as a measure of the distance between genes was explained by :
- (1) T.H. Morgan (2) Gregor J. Mendel
(3) Alfred Sturtevant (4) Sutton Boveri
166. Match the following genes of the Lac operon with their respective products :
- (a) i gene (i) β -galactosidase
(b) z gene (ii) Permease
(c) a gene (iii) Repressor
(d) y gene (iv) Transacetylase
- Select the correct option.
- | | | | |
|-----------|-------|------|------|
| (a) | (b) | (c) | (d) |
| (1) (i) | (iii) | (ii) | (iv) |
| (2) (iii) | (i) | (ii) | (iv) |
| (3) (iii) | (i) | (iv) | (ii) |
| (4) (iii) | (iv) | (i) | (ii) |
167. It takes very long time for pineapple plants to produce flowers. Which combination of hormones can be applied to artificially induce flowering in pineapple plants throughout the year to increase yield?
- (1) Auxin and Ethylene
(2) Gibberellin and Cytokinin
(3) Gibberellin and Abscisic acid
(4) Cytokinin and Abscisic acid
168. Identify the cells whose secretion protects the lining of gastro-intestinal tract from various enzymes.
- (1) Chief Cells (2) Goblet Cells
(3) Oxyntic Cells (4) Duodenal Cells
169. Which of the following can be used as a biocontrol agent in the treatment of plant disease?
- (1) *Trichoderma* (2) *Chlorella*
(3) *Anabaena* (4) *Lactobacillus*
170. Phloem in gymnosperms lacks :
- (1) Albuminous cells and sieve cells
(2) Sieve tubes only
(3) Companion cells only
(4) Both sieve tubes and companion cells
171. Extrusion of second polar body from egg nucleus occurs :
- (1) after entry of sperm but before fertilization
(2) after fertilization
(3) before entry of sperm into ovum
(4) simultaneously with first cleavage
172. Under which of the following conditions will there be no change in the reading frame of following mRNA?
5'AACAGCGGUGCUAUU3'
- (1) Insertion of G at 5th position
(2) Deletion of G from 5th position
(3) Insertion of A and G at 4th and 5th positions respectively
(4) Deletion of GGU from 7th, 8th and 9th positions
- 173 The concept of "*Omnis cellula-e cellula*" regarding cell division was first proposed by
- (1) Rudolf Virchow
(2) Theodor Schwann
(3) Schleiden
(4) Aristotle
- 174 What triggers activation of protoxin to active Bt toxin of *Bacillus thuringiensis* in boll worm?
- (1) Body temperature
(2) Moist surface of midgut
(3) Alkaline pH of gut
(4) Acidic pH of stomach
- 175 Identify the correct pair representing the causative agent of typhoid fever and the confirmatory test for typhoid.
- (1) *Plasmodium vivax* / UTI test
(2) *Streptococcus pneumoniae* / Widal test
(3) *Salmonella typhi* / Anthrone test
(4) *Salmonella typhi* / Widal test
176. What is the genetic disorder in which an individual has an overall masculine development gynaecomastia, and is sterile ?
- (1) Turner's syndrome
(2) Klinefelter's syndrome
(3) Edward syndrome
(4) Down's syndrome

177. Polyblend, a fine powder of recycled modified plastic, has proved to be a good material for

- (1) Making plastic sacks
- (2) Use as a fertilizer
- (3) Construction of roads
- (4) Making tubes and pipes

178. Which of these following methods is the most suitable for disposal of nuclear waste?

- (1) Shoot the waste into space
- (2) Bury the waste under Antarctic ice-cover
- (3) Dump the waste within rocks under deep ocean
- (4) Bury the waste within rocks deep below the Earth's surface

179. Match the following hormones with the respective disease

- | | |
|--------------------|-------------------------|
| (a) Insulin | (i) Addison's disease |
| (b) Thyroxin | (ii) Diabetes insipidus |
| (c) Corticoids | (iii) Acromegaly |
| (d) Growth Hormone | (iv) Goitre |
| | (v) Diabetes mellitus |

Select the correct option.

- | | (a) | (b) | (c) | (d) |
|-----|------|------|-------|-------|
| (1) | (v) | (i) | (ii) | (iii) |
| (2) | (ii) | (iv) | (iii) | (i) |
| (3) | (v) | (iv) | (i) | (iii) |
| (4) | (ii) | (iv) | (i) | (iii) |

180. Select the correct option.

- (1) 8th, 9th and 10th pairs of ribs articulate directly with the sternum.
- (2) 11th and 12th pairs of ribs are connected to the sternum with the help of hyaline cartilage.
- (3) Each rib is a flat thin bone and all the ribs are connected dorsally to the thoracic vertebrae and ventrally to the sternum.
- (4) There are seven pairs of vertebrosteral, three pairs of vertebrochondral and two pairs of vertebral ribs.



CODE: P1 – Answer Key:

1. (3)	2. (3)	3. (1)	4. (2)	5. (2)	6. (4)	7. (3)	8. (1)	9. (1)	10. (2)
11. (2)	12. (2)	13. (2)	14. (4)	15. (3)	16. (4)	17. (2)	18. (2)	19. (4)	20. (4)
21. (1)	22. (3)	23. (4)	24. (3)	25. (2)	26. (3)	27. (3)	28. (4)	29. (3)	30. (3)
31. (1)	32. (1)	33. (3)	34. (4)	35. (3)	36. (3)	37. (2)	38. (1)	39. (3)	40. (2)
41. (4)	42. (4)	43. (2)	44. (2)	45. (3)	46. (1)	47. (2)	48. (1)	49. (1)	50. (1)
51. (1)	52. (4)	53. (1)	54. (2)	55. (2)	56. (3)	57. (1)	58. (4)	59. (3)	60. (2)
61. (2)	62. (1)	63. (3)	64. (3)	65. (2)	66. (1)	67. (3)	68. (3)	69. (4)	70. (3)
71. (3)	72. (1,2)	73. (1)	74. (3)	75. (2)	76. (4)	77. (3)	78. (2)	79. (2)	80. (1)
81. (4)	82. (3)	83. (4)	84. (3)	85. (3)	86. (4)	87. (2)	88. (2)	89. (4)	90. (1)
91. (2)	92. (4)	93. (2)	94. (2)	95. (2)	96. (2)	97. (3)	98. (1)	99. (2)	100. (1)
101. (1)	102. (4)	103. (2)	104. (4)	105. (1)	106. (3)	107. (2)	108. (4)	109. (2)	110. (4)
111. (4)	112. (3)	113. (4)	114. (3)	115. (2)	116. (2)	117. (3)	118. (2)	119. (3)	120. (2)
121. (3)	122. (2)	123. (2)	124. (3)	125. (2)	126. (4)	127. (4)	128. (2)	129. (3)	130. (3)
131. (4)	132. (2)	133. (2)	134. (4)	135. (1)	136. (4)	137. (4)	138. (3)	139. (1)	140. (1)
141. (1)	142. (4)	143. (4)	144. (2)	145. (2)	146. (3)	147. (4)	148. (2)	149. (2)	150. (3)
151. (3)	152. (1)	153. (2)	154. (3)	155. (3)	156. (3)	157. (2)	158. (1)	159. (4)	160. (4)
161. (4)	162. (4)	163. (3)	164. (1)	165. (3)	166. (3)	167. (1)	168. (2)	169. (1)	170. (4)
171. (1)	172. (4)	173. (1)	174. (3)	175. (4)	176. (2)	177. (3)	178. (4)	179. (3)	180. (4)